



# Primescan Connect™: Easy scan, seamless collaboration

A fast and accurate intraoral scanner, now in a touchscreen laptop configuration

[Learn more >](#)





# Digital impressions are fast, accurate and more comfortable

## A simple scan is all it takes

Primescan® is an intraoral scanner that allows you to perform high-precision digital impressions of the patient's mouth, without the use of conventional impression material.

## Better results for you, better outcomes for your patients

Digital impressions are transforming the dental practice by:

- Helping to optimize diagnostics and treatment planning
- Supporting financial growth
- Enabling the delivery of high-quality patient care

Primescan helps to increase patient comfort and fitting accuracy

**80%**

of patients feel more confident that they are getting excellent dental care when you choose digital technology such as an intraoral scanner.<sup>1</sup>

1. US Patient Survey, May 2020, N=254 US Adult Dental Patients.





# Primescan Connect: the easy way to start

All the benefits of Primescan are now available in an accessible solution, making it an easy starting point in digital dentistry. **Primescan Connect** is a fast and accurate intraoral scanner that comes in a laptop configuration. Primescan Connect is easy to use, adopt and delegate. Plus, the laptop is included, so you can start scanning right away, and it also comes with a touchscreen for optimal ergonomics during your scanning workflow.

## Everything you need to get started in digital dentistry

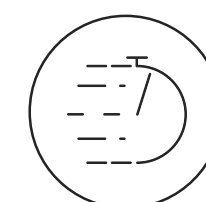

### Speed<sup>1</sup>

Full arch scan in less than a minute

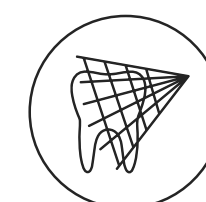

### Accuracy

Excellent scans no matter which material or how difficult it is to capture the area



### Ease of Use

Helps to simplify the scanning process, so you can delegate and spend more time with your patients



### Connectivity

Powered by DS Core™, so you can share intraoral scans together with other case files to collaborate seamlessly with lab partners and colleagues

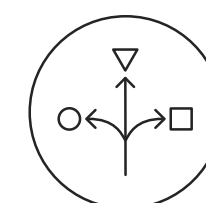

### Flexibility

Takes up only a little space and is easy to integrate into any workflow and practice set-up

Primescan Connect offers high performance at an accessible price.

Primescan's accuracy has been proven in several studies. For more detail, please refer to the [Dentsply Sirona Clinical Study Overview](#)

1. From Connect SW 5.2. Internal data on file.

# Enjoy the scan with our latest technology

Primescan Connect completes a full arch scan in **less than 1 minute**, which means more comfort for your patients.

- Future-proof patented technology
- Easy scanning of deep cavities and steep inclines
- Simple scanning of large edentulous areas and palates
- Smooth scanning of reflective materials, like metal crowns, meaning no limitations in case selection
- Unique three sleeve concept and a variety of cleaning and disinfection options, exceeding the minimum recommended hygiene guidelines
- Fully closed scanning window to prevent liquid infiltration during the scanning process

Engineered for a very high level of performance



[Click on the device feature to learn more](#)

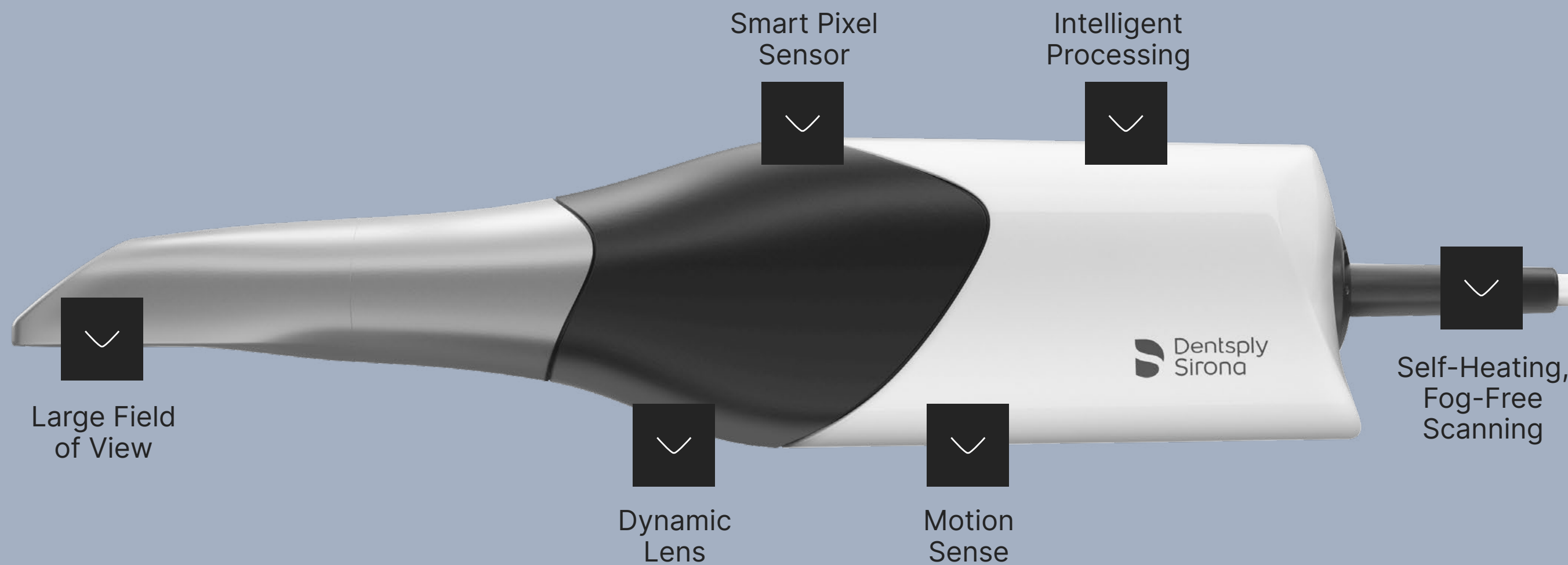

With three different sleeves, you can easily integrate the intraoral scanner into your hygiene concept



Autoclavable steel sleeve with single-use window.



Disposable sleeve meeting hygiene requirements to prevent cross-contamination.



Steel sleeve with sapphire glass window that can be sterilized with dry heat or treated with high-level disinfection (HLD).



# Provide an excellent treatment experience

# What dentists and patients think

“My case acceptance has gone up tremendously and anxiety is not an issue anymore. Patients can see what I see. When I show them where the crack is, where the missing filling is, that builds that trust factor much easier, much better.”

**Dr. Isaa Bina, USA**

“Coming to Dr. Bina has been life-changing because I went from being really scared and anxious to now being open to any procedure actually.”

**Patient**

## Benefits for your patients



### Enhance patient experience

Provide your patients with a fast and comfortable treatment experience.



### Educate your patients

Share information with your patients to help them decide on the treatment possibilities.

## Benefits for you and your practice



### Increase case acceptance

Offer a better patient experience to increase treatment acceptance and thus, profitability.

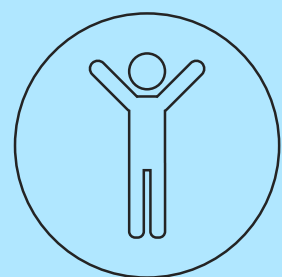

### Enhance your practice image

Stay competitive in the market by setting apart your practice.





# Work more efficiently with DS Core<sup>1</sup>

Get the most out of your Primescan Connect with Dentsply Sirona's cloud-based solution: **DS Core**.



**Store your patient files in one location** to enable efficient workflows in your practice. Accessible via web browser your patients' files are always available, wherever you are and whenever you need them.

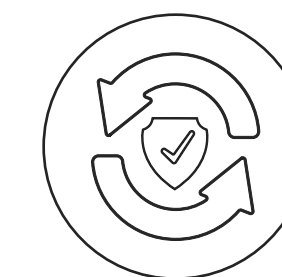

DS Core supports GDPR/HIPAA **compliant file-sharing** all from one platform. Seamlessly and securely collaborate with colleagues and external partners or share images with annotations directly with patients for their review at home.

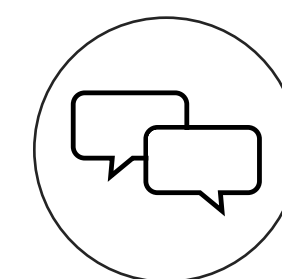

With the user-friendly **communication canvas**, you can view, arrange, and annotate the full-color 3D intraoral scans and combine them with additional compatible image formats, facilitating patient communication, comprehension, and case acceptance.



DS Core connects your practice with your lab, making it easy to **place and manage your orders** allowing a simple and supportive communication and collaboration.

1. DS Core is not a medical device software. It is not intended to diagnose, treat, cure, or prevent any disease or health condition. Use only for information, education or sharing purposes. Service is subject to country availability. Please contact your local DS representative for more details.



# From the practice to the lab

Primescan Connect is an open scanner, which means you can send data to any lab of your choice in the format they need. With DS Core the process of ordering from your lab is simple and seamless.

**99%**

LAB ACCEPTANCE RATE of Dentsply Sirona scan data.<sup>1</sup>

1. Internal unpublished data.

## DS Core is becoming your one unified portal for all orders and services:

- Work with your favorite lab(s) or find new providers within the platform
- Create digital orders to dental labs within seconds
- Manage all cases, orders, files, and messages in one place
- DS Core supports GDPR/HIPAA compliance
- Send additional data such as patient images, X-rays and other patient files
- Access to validated workflows from Dentsply Sirona
- Place orders with DS Core Create for ready-to-print indications designs
- Place orders for SureSmile® aligners

## Collaboration made easy

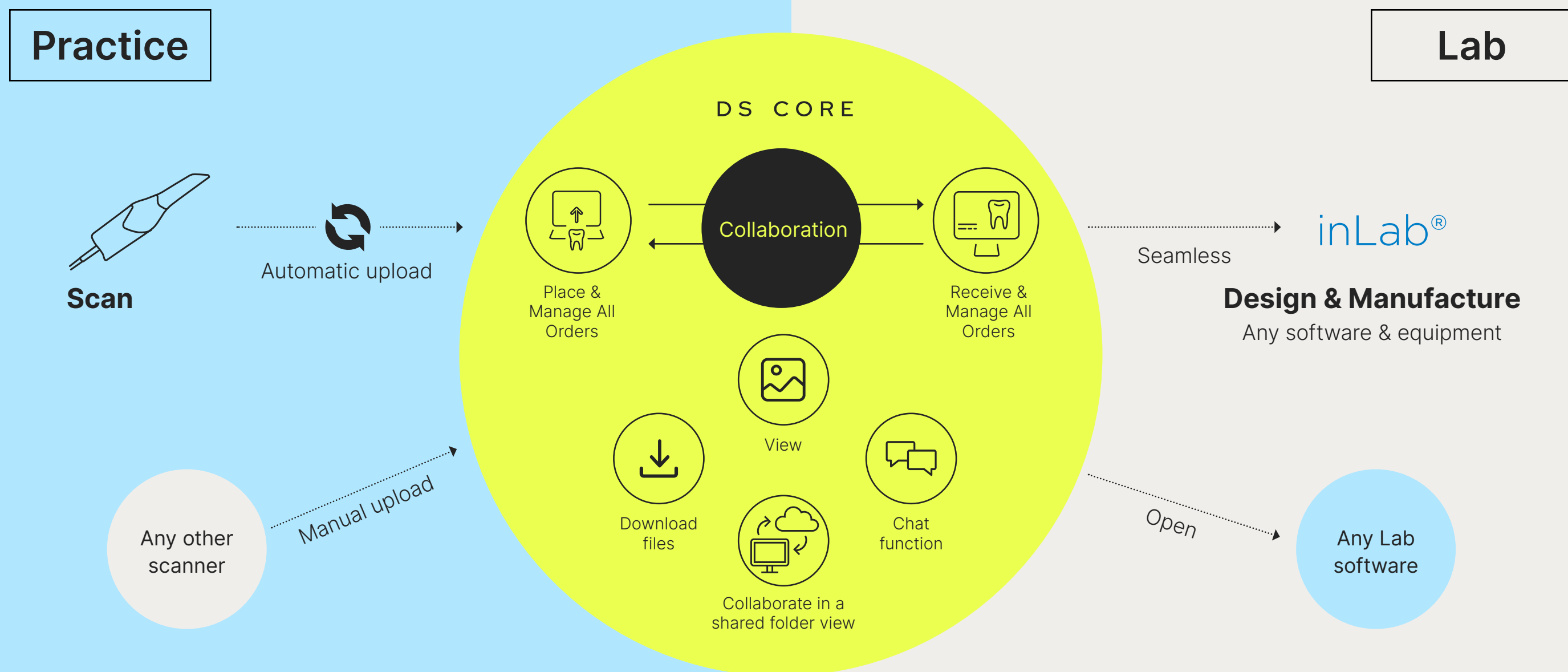

# Expand into different workflows

From treatment of single units to more challenging cases, Primescan Connect supports you when you're performing every procedure. You can integrate it into your most requested dental treatments while also expanding your workflow possibilities, so you can grow your practice and offer an excellent patient experience. Find out more about each workflow by clicking on the corresponding icon below.

Digitalize your workflows while keeping your established relationships. Your lab technician will appreciate the great scan results and easy data transfer for all restorative indications.

- Indirect restorations**  
Crowns, inlays, onlays, bridges
- Implant restorations**  
Abutments, screw-retained crowns
- Esthetics**  
Veneers, smile makeovers



Restorative

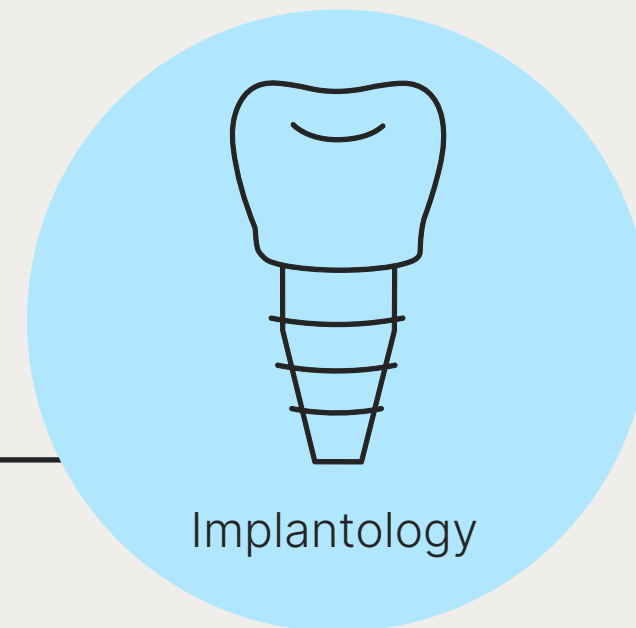

Implantology

- Implantology**  
[DS PrimeTaper™](#)  
Including a modern tapered implant, harmonized prosthetic options and a surgical and prosthetic kit
- Guided surgery**  
Surgical guides with [Simplant®](#)

Make use of various workflow options for both implant surgery and implant prosthetics. Directly connect to great partners such as [Simplant](#) and [Atlantis](#). Primescan Connect is also validated for Atlantis suprastructures.<sup>1</sup>

Primescan Connect also opens the door to digital orthodontics. Take advantage of the seamless Dentsply Sirona workflow with SureSmile aligners for a quick and efficient treatment or order orthodontic appliances from other specialized partners.

- Clear aligners**  
[SureSmile](#) and other 3rd party providers

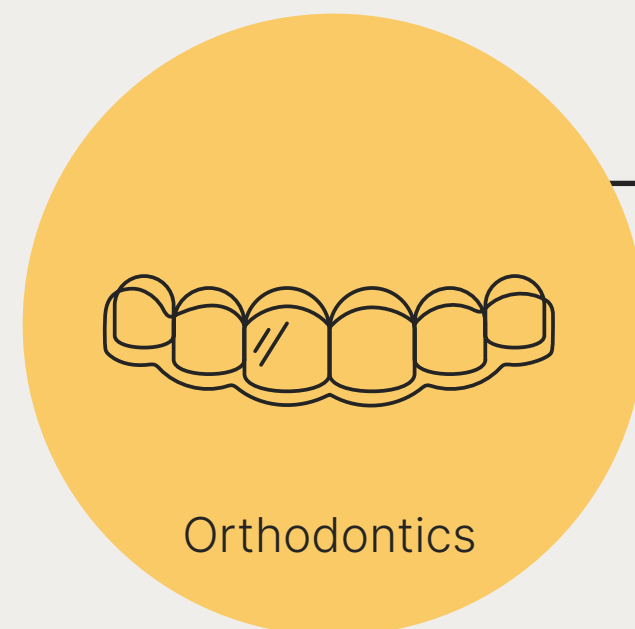

Orthodontics

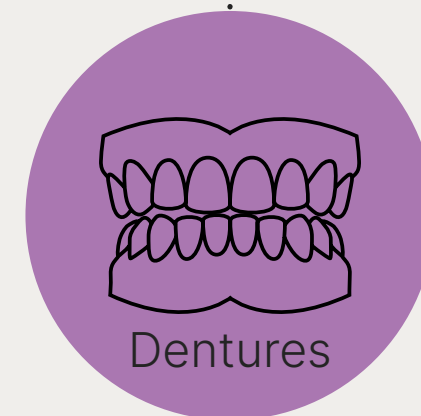

Dentures

IT ALL STARTS WITH A SCAN

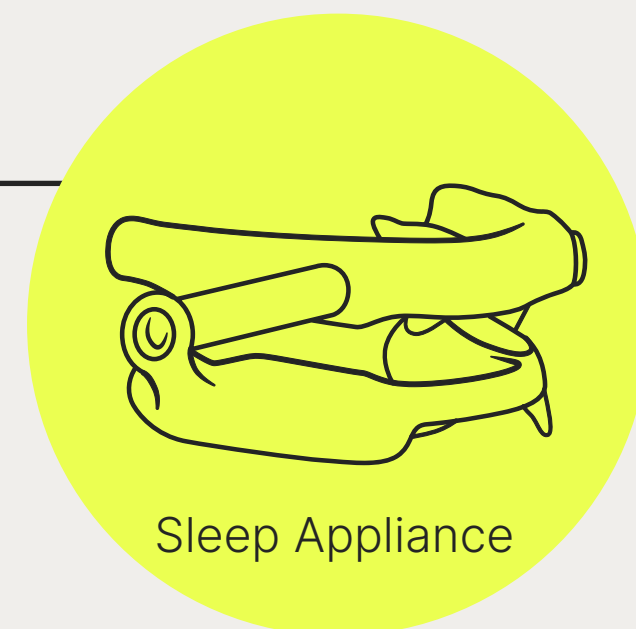

Sleep Appliance

- Sleep devices**  
[Panthera Dental®](#)  
Validated workflows to our partners Panthera sleep and [Resmed](#) custom-made devices
- Splints**  
(e.g., Night guards, jaw therapies)

Expand your range of applications in the field of sleep appliances. Send the scan data to our validated partners Panthera and Resmed to order high quality customized sleep devices and splints, or order at your preferred provider.

Increase patient comfort by digitalizing dentures. Reduce postoperative adjustments and patient visits to the practice. Follow the Primescan's Reference Denture Scan Strategy to create digital models of dentures and send the data to your preferred lab.

1. Full-arch fixed implant restorations based on Atlantis IO-FLO S scanbodies.



Learn more at: Customer Support Portal  
[dentsplysirona.com/csp](https://dentsplysirona.com/csp)



# DS Core™ Care: run your practice with a high level of efficiency

DS Core Care is the advanced service and support solution for your Primescan Connect. It provides you the comfort to have your intraoral scanner readily available when you need it, even if the unforeseen happens. Direct access to qualified and dedicated service experts and express replacement options allow you to fully take advantage of your Primescan Connect – for a long time.



### Hotline Support

Access to technical phone support from qualified service experts for direct problem solving when you need it.

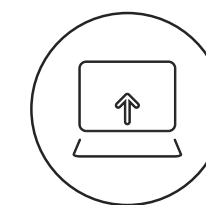

### Customer Support Portal

For immediate answers and self-support, the portal provides product and workflow information – always accessible in one single place.

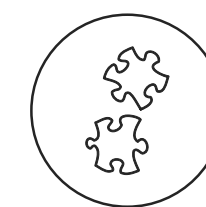

### Spare Parts

Quick supply of spare parts from the original manufacturer to help minimize downtime and avoid additional costs.

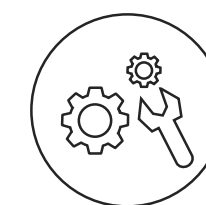

### Fast Service Clarification

With the connection of your device to DS Core, you can benefit from remote, real-time, efficient troubleshooting, limiting unnecessary follow ups and saving your time.

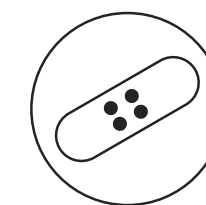

### Accidental damage coverage

Receive a new Primescan Connect in case of unexpected incidents or even accidental damages.

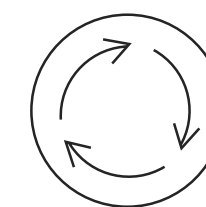

### Express Replacement

Receive a replacement Primescan Connect with shipment on the next business day<sup>1</sup> after remote diagnoses. Labor and travel costs included.

The laptop model availability or specification may vary according to country. The laptop is covered by Dell ProSupport Plus service. Please contact your local Dentsply Sirona representative to confirm availability of DS Core Care in your country.

1. Where available.



# Take your first step into digital dentistry with confidence

With Primescan Connect, you can step into a digital world of possibilities. By connecting you with expert labs, streamlining your existing workflows and allowing you to easily integrate new procedures, Primescan Connect can help you run your practice more smoothly and grow with confidence.

## **Provide an excellent treatment experience**

with the high-precision intraoral scanning technology of Primescan Connect

## **Collaborate seamlessly with lab partners and colleagues**

with DS Core, the innovative cloud storage and file-sharing platform

## **Order at your lab of choice**

as an open scanner, Primescan Connect has validated connections to all major lab CAD software, allowing you to share data with any lab or partner of your choice

**Grow with Primescan Connect. Integrate it into your existing procedures and use it to expand into new digital workflows.**

[Learn more >](#)



**With Primescan Connect, you can focus on what matters most: treating your patients.**



Digital Impression

High Performance

Collaboration

Workflows

Service & Support

Summary

## Dentsply Sirona

Sirona Dental Systems GmbH  
Fabrikstraße 31, 64625 Bensheim, Germany  
[dentsplysirona.com](https://dentsplysirona.com)

Subject to technical changes and errors in the text, Order No. A91100-M43-C353-01-7600, 06/2023.

Registered trademarks, trade names and logos are used. Even if these are not identified as such in the respective places, the corresponding legal provisions apply.

Unless otherwise stated, all comparative statements in this document refer to a comparison of Dentsply Sirona products with each other.

---

THE DENTAL  
SOLUTIONS  
COMPANY™



# Enjoy the scan with our latest technology

Primescan Connect completes a full arch scan in **less than 1 minute**, which means more comfort for your patients.

- Future-proof patented technology
- Easy scanning of deep cavities and steep inclines
- Simple scanning of large edentulous areas and palates
- Smooth scanning of reflective materials, like metal crowns, meaning no limitations in case selection
- Unique three sleeve concept and a variety of cleaning and disinfection options, exceeding the minimum recommended hygiene guidelines
- Fully closed scanning window to prevent liquid infiltration during the scanning process

## Engineered for a very high level of performance

### Faster and smoother scanning

The innovative **smart pixel sensor** processes more than 50,000 images per second, producing photorealistic and highly accurate data. By scanning at an incredible data density, Primescan Connect delivers complete 3D structures of everything in its field of view – from the very first scan.

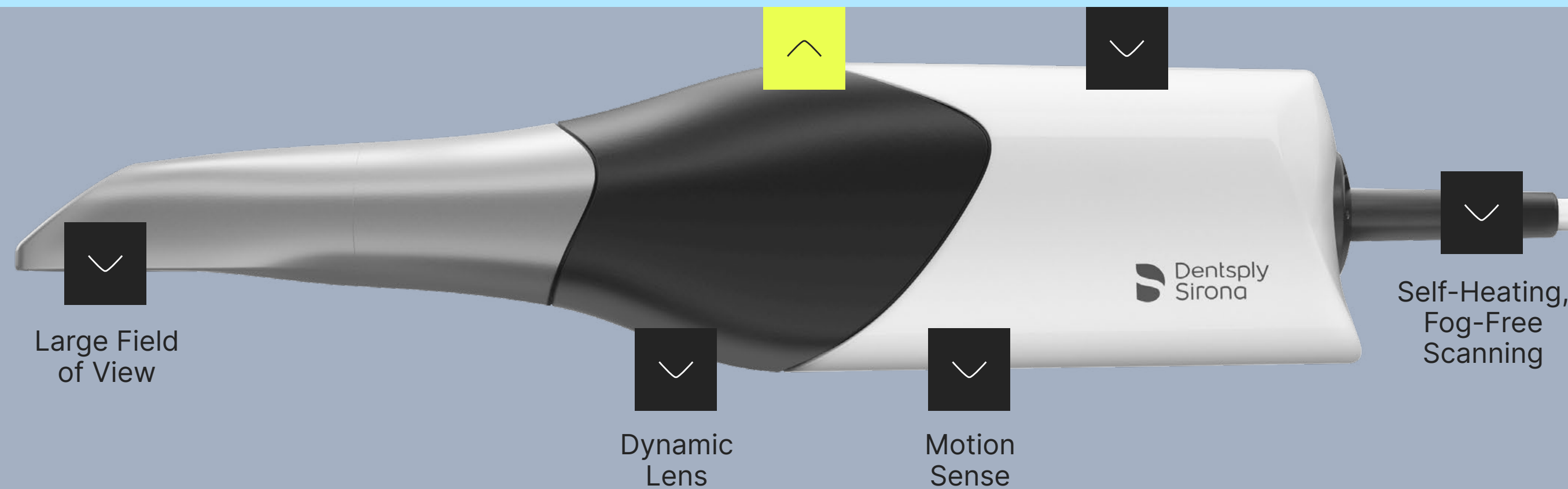

## With three different sleeves, you can easily integrate the intraoral scanner into your hygiene concept



Autoclavable steel sleeve with single-use window.



Disposable sleeve meeting hygiene requirements to prevent cross-contamination.



Steel sleeve with sapphire glass window that can be sterilized with dry heat or treated with high-level disinfection (HLD).

# Enjoy the scan with our latest technology

Primescan Connect completes a full arch scan in **less than 1 minute**, which means more comfort for your patients.

- Future-proof patented technology
- Easy scanning of deep cavities and steep inclines
- Simple scanning of large edentulous areas and palates
- Smooth scanning of reflective materials, like metal crowns, meaning no limitations in case selection
- Unique three sleeve concept and a variety of cleaning and disinfection options, exceeding the minimum recommended hygiene guidelines
- Fully closed scanning window to prevent liquid infiltration during the scanning process

Engineered for a very high level of performance

### Faster calculation and fewer interruptions

**Intelligent Processing** enables seamless collaboration with the software by transmitting all the data needed to proceed. Real-time artifact removal is automatically performed while scanning to keep the model clean.

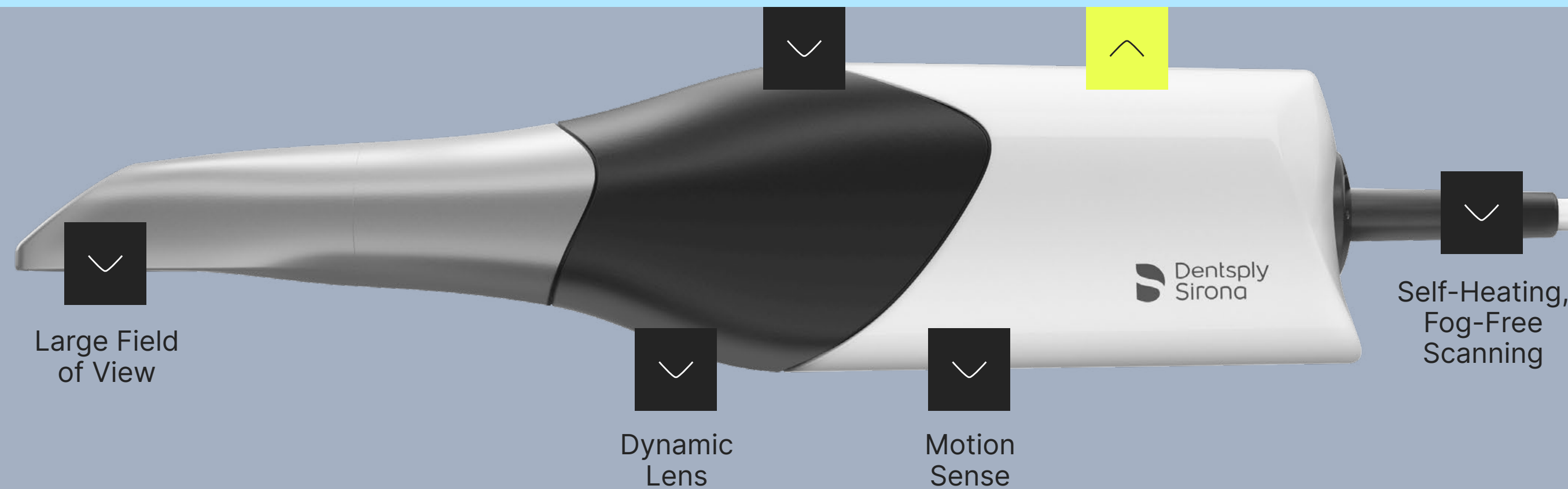

With three different sleeves, you can easily integrate the intraoral scanner into your hygiene concept



Autoclavable steel sleeve with single-use window.



Disposable sleeve meeting hygiene requirements to prevent cross-contamination.



Steel sleeve with sapphire glass window that can be sterilized with dry heat or treated with high-level disinfection (HLD).

# Enjoy the scan with our latest technology

Primescan Connect completes a full arch scan in **less than 1 minute**, which means more comfort for your patients.

- Future-proof patented technology
- Easy scanning of deep cavities and steep inclines
- Simple scanning of large edentulous areas and palates
- Smooth scanning of reflective materials, like metal crowns, meaning no limitations in case selection
- Unique three sleeve concept and a variety of cleaning and disinfection options, exceeding the minimum recommended hygiene guidelines
- Fully closed scanning window to prevent liquid infiltration during the scanning process

Engineered for a very high level of performance



Click on the device feature to learn more

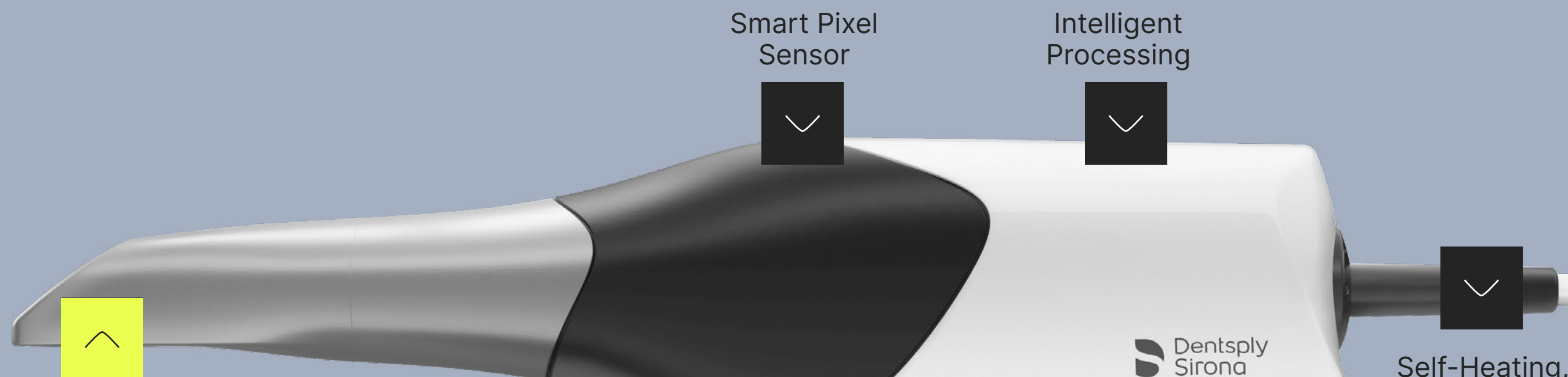

### You get what you need

Primescan Connect's **large field of view** captures everything that is within its view. Its dynamic depth scan technology enables excellent sharpness and precision even at a measuring depth up to 20mm – a crucial advantage for subgingival indications. The automatic artifact removal cuts out extraneous data such as a cheek, tongue or finger in real time during a scan.

With three different sleeves, you can easily integrate the intraoral scanner into your hygiene concept



Autoclavable steel sleeve with single-use window.



Disposable sleeve meeting hygiene requirements to prevent cross-contamination.



Steel sleeve with sapphire glass window that can be sterilized with dry heat or treated with high-level disinfection (HLD).

# Enjoy the scan with our latest technology

Primescan Connect completes a full arch scan in **less than 1 minute**, which means more comfort for your patients.

- Future-proof patented technology
- Easy scanning of deep cavities and steep inclines
- Simple scanning of large edentulous areas and palates
- Smooth scanning of reflective materials, like metal crowns, meaning no limitations in case selection
- Unique three sleeve concept and a variety of cleaning and disinfection options, exceeding the minimum recommended hygiene guidelines
- Fully closed scanning window to prevent liquid infiltration during the scanning process

Engineered for a very high level of performance



Click on the device feature to learn more

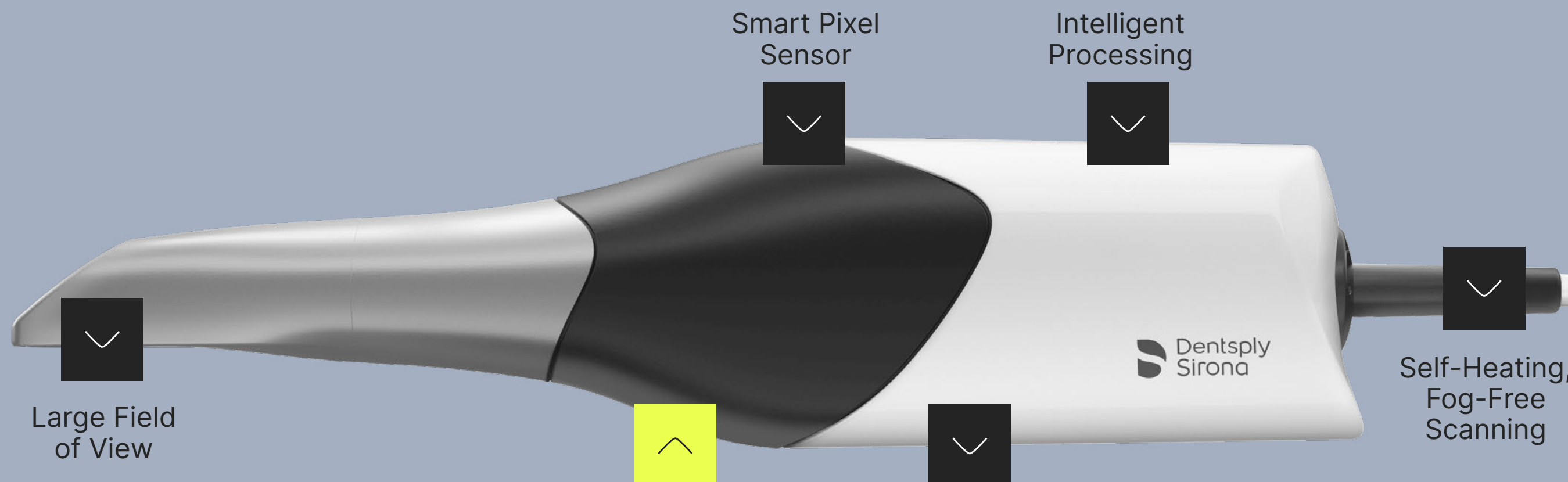

### Dynamic Lens

It supports you when you're capturing difficult-to-reach areas.

With three different sleeves, you can easily integrate the intraoral scanner into your hygiene concept



Autoclavable steel sleeve with single-use window.



Disposable sleeve meeting hygiene requirements to prevent cross-contamination.



Steel sleeve with sapphire glass window that can be sterilized with dry heat or treated with high-level disinfection (HLD).

# Enjoy the scan with our latest technology

Primescan Connect completes a full arch scan in **less than 1 minute**, which means more comfort for your patients.

- Future-proof patented technology
- Easy scanning of deep cavities and steep inclines
- Simple scanning of large edentulous areas and palates
- Smooth scanning of reflective materials, like metal crowns, meaning no limitations in case selection
- Unique three sleeve concept and a variety of cleaning and disinfection options, exceeding the minimum recommended hygiene guidelines
- Fully closed scanning window to prevent liquid infiltration during the scanning process

Engineered for a very high level of performance



[Click on the device feature to learn more](#)

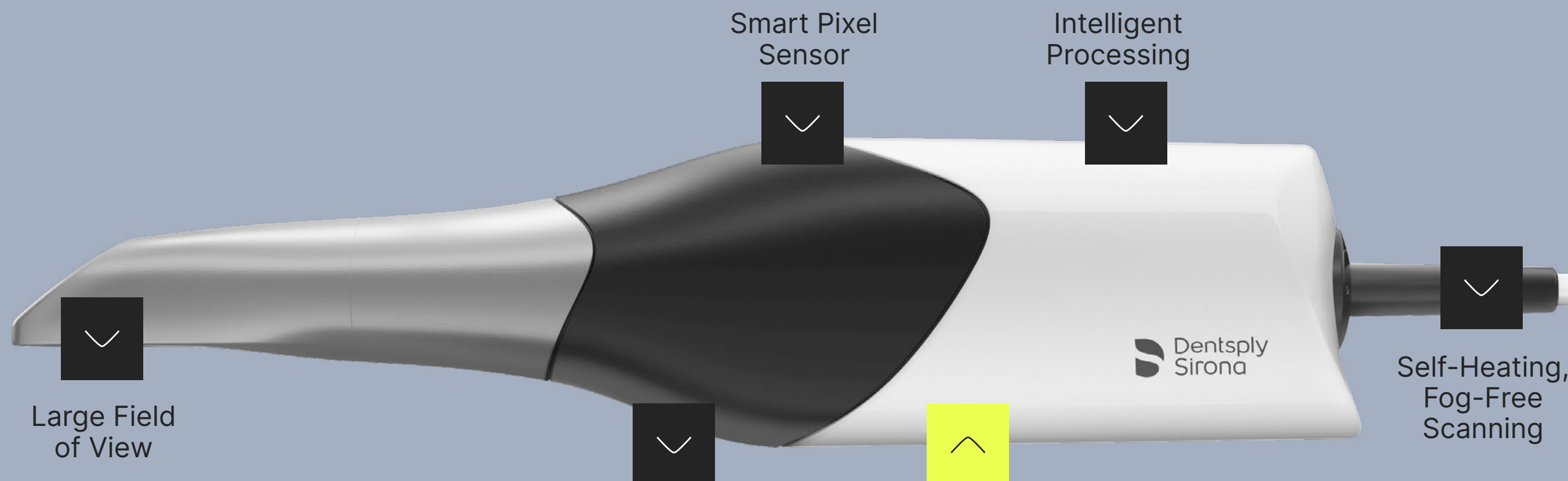

### Motion Sense

The scanner is switched on automatically when removed from its cradle. Scanning can start less than 1 second after automatic activation.

With three different sleeves, you can easily integrate the intraoral scanner into your hygiene concept



Autoclavable steel sleeve with single-use window.



Disposable sleeve meeting hygiene requirements to prevent cross-contamination.



Steel sleeve with sapphire glass window that can be sterilized with dry heat or treated with high-level disinfection (HLD).



# Enjoy the scan with our latest technology

Primescan Connect completes a full arch scan in **less than 1 minute**, which means more comfort for your patients.

- Future-proof patented technology
- Easy scanning of deep cavities and steep inclines
- Simple scanning of large edentulous areas and palates
- Smooth scanning of reflective materials, like metal crowns, meaning no limitations in case selection
- Unique three sleeve concept and a variety of cleaning and disinfection options, exceeding the minimum recommended hygiene guidelines
- Fully closed scanning window to prevent liquid infiltration during the scanning process

Engineered for a very high level of performance



[Click on the device feature to learn more](#)

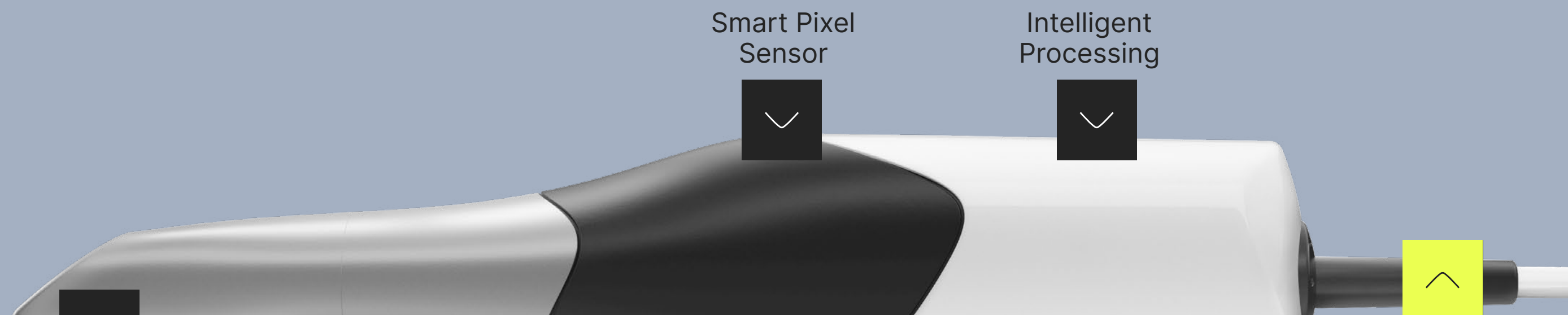

### Start scanning right away

Primescan Connect offers continuous **self-heating, fog-free scanning** – which means you are always ready to scan.

With three different sleeves, you can easily integrate the intraoral scanner into your hygiene concept



Autoclavable steel sleeve with single-use window.



Disposable sleeve meeting hygiene requirements to prevent cross-contamination.



Steel sleeve with sapphire glass window that can be sterilized with dry heat or treated with high-level disinfection (HLD).